



**1/6.5'' VGA CMOS Image Sensor
GC0308**

DataSheet

2010-01-28

GalaxyCore Inc.

Content

1.	Sensor Overview	3
1.1	General Description	3
1.2	Features	3
1.3	Application	4
1.4	Technical Specifications	4
1.5	Block Diagram	5
1.6	Pixel Array	6
2.	Color Filter Spectral Characteristics	6
3.	Two-wire Serial Bus Communication	7
3.1	Protocol	7
3.2	Serial Bus Timing	8
4.	Timing.....	9
5.	DC Parameters	10
6.	Register List	10
7.	Pin Description	30
7.1	GC0308 CSP package Top view (unit:um)	30
7.2	CSP ball description	30
7.3	GC0308 chip pin description	30
7.4	CSP package mechanical drawing (unit:um)	32

1. Sensor Overview

1.1 General Description

The GC0308 features 640V x 480H resolution with 1/6.5-inch optical format, and 4-transistor pixel structure for high image quality and low noise variations. It delivers superior image quality by powerful on-chip design of a 10-bit ADC, and embedded image signal processor.

The full scale integration of high-performance and low-power functions makes the GC0308 best fit the design, reduce implementation process, and extend the battery life of cell phones, PDAs, and a wide variety of mobile applications.

The on-chip ISP provides a very smooth AE (Auto Exposure) and accurate AWB(Auto White Balance) control. It provides various data formats, such as Bayer RGB, RGB565, YCbCr 4:2:2. It has a commonly used two-wire serial interface for host to control the operation of the whole sensor.

The product is capable of operating at up to 30 frames per second at 24MHZ clock in VGA mode, with complete user control over image quality and data formatting.

1.2 Features

- ◆ Standard optical format of 1/6.5 inch
- ◆ Motion detect function
- ◆ Bar code identification
- ◆ Various output formats: YCbCr4:2:2, RGB565, Raw Bayer
- ◆ Single power supply requirement (2.8v)
- ◆ Windowing support
- ◆ Horizontal /Vertical mirror
- ◆ Image processing module

- ◆ Package: CSP

1.3 Application

- ◆ Cellular Phone Cameras
- ◆ Notebook and desktop PC cameras
- ◆ Toys
- ◆ Digital still cameras and camcorders
- ◆ Video telephony and conferencing equipments
- ◆ Security systems
- ◆ Bar code reader

1.4 Technical Specifications

Parameter	Typical value
Optical Format	1/6.5 inch
Pixel Size	3.4um x 3.4um
Active pixel array	648 x 488
ADC resolution	10 bit ADC
Max Frame rate	30fps@24Mhz,VGA
Power Supply	2.7 ~ 3.3V, typical 2.8V
Power Consumption	70mW @ 30fps VGA, 10uA @ standby
SNR	TBD
Dark Current	TBD
Sensitivity	TBD
Operating temperature:	-30~80°C
Stable Image temperature	-10~60°C
Optimal lens chief ray angle(CRA)	25°
Package type	CSP

1.5 Block Diagram

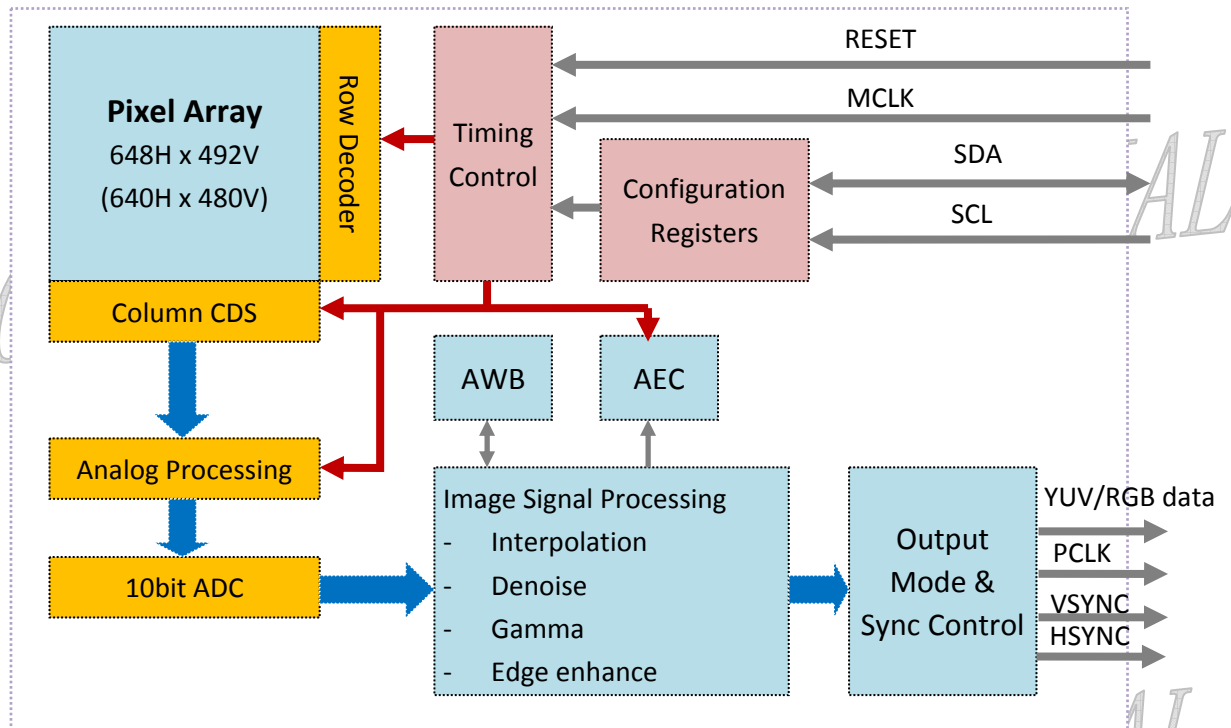

GC0308 has an active image array of 648x488 pixels. The active pixels are read out progressively through column/row driver circuits. In order to reduce fixed pattern noise, CDS circuits are adopted. The analog signal is transferred to digital signal by 10 bit A/D converter. The digital signals are processed in the ISP Block, including Bayer interpolation, De-noise, color correction, gamma correction, data format conversion and so on. Users can easily control these functions via two-wire serial interface bus.

1.6 Pixel Array

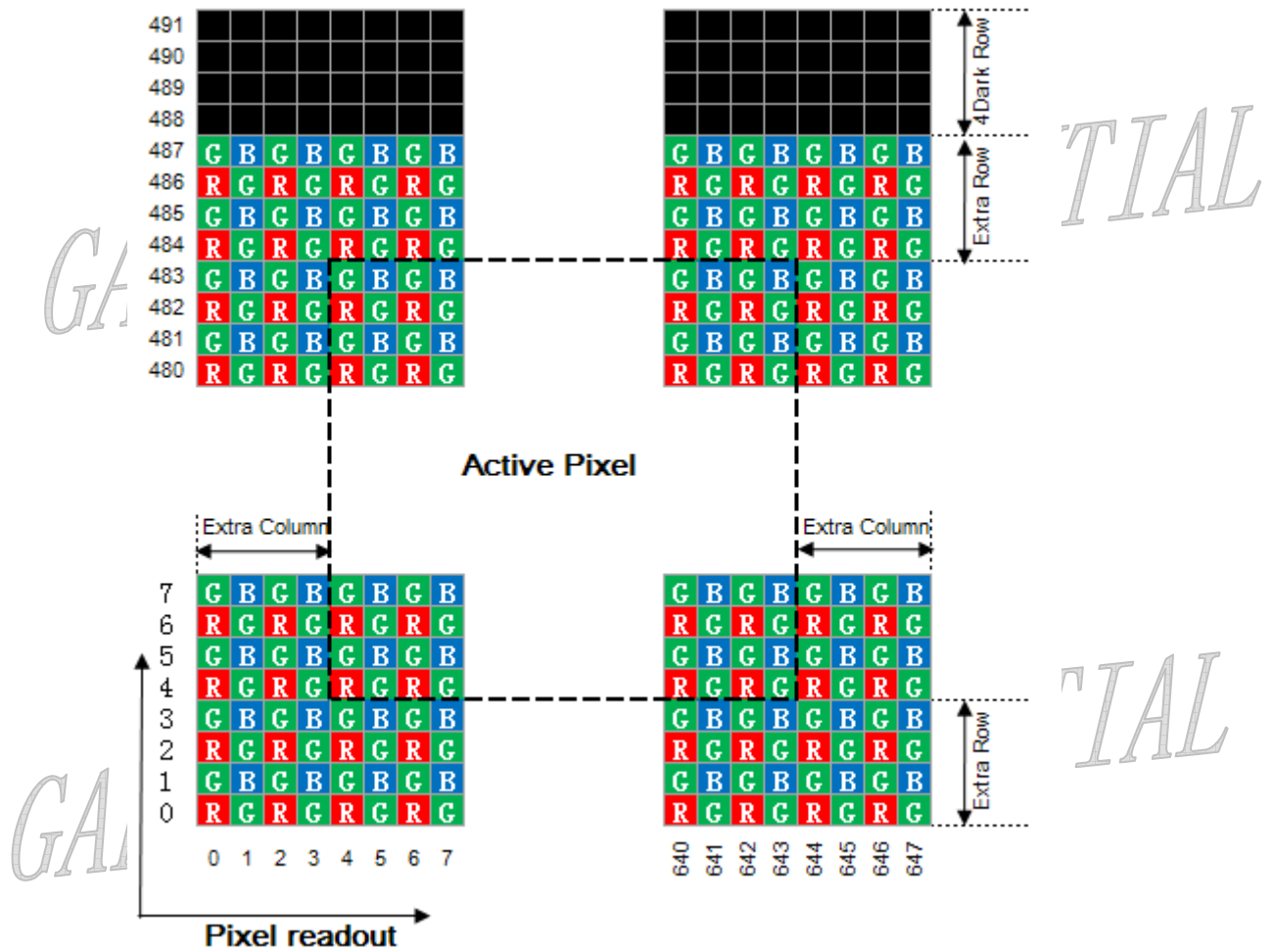

Pixel array is covered by Bayer pattern color filters. The primary color BG/GR array is arranged in line-alternating way.

If no flip in column, column is read out from 0 to 647. If flip in column, column is read out from 647 to 0.

If no flip in row, row is read out from 0 to 487. If flip in row, row is read out from 487 to 0.

2. Color Filter Spectral Characteristics

The optical spectrum of color filters is shown below

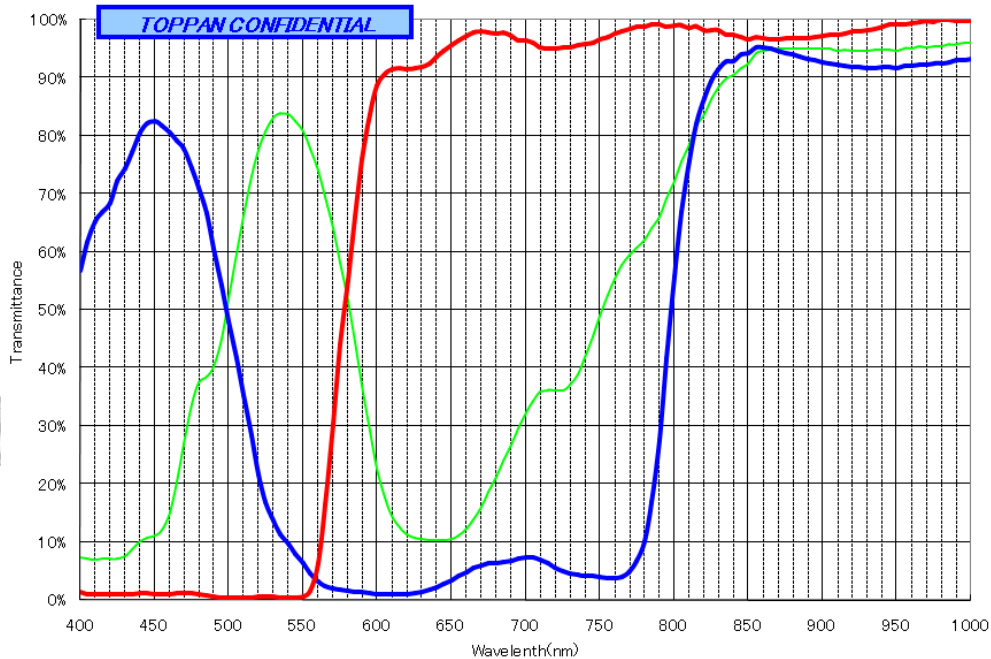

3. Two-wire Serial Bus Communication

GC0308 Device Address:

serial bus write address = 0x42, serial bus read address = 0x43

3.1 Protocol

The host must perform the role of a communications master and GC0308 acts as either a slave receiver or transmitter. The master must do

- ◆ Generate the **Start(S)/Stop(P)** condition
- ◆ Provide the serial clock on **SBCL**.

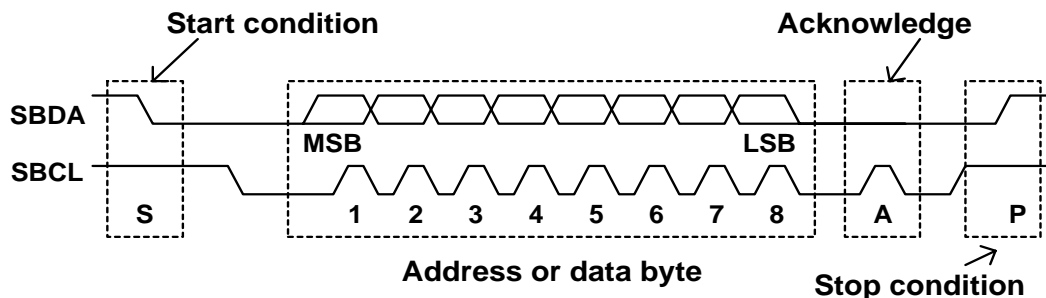

Single Register Writing:

S	42H	A	Register Address	A	Data	A	P
---	-----	---	------------------	---	------	---	---

Incremental Register Writing:

S	42H	A	Register Address	A	Data(1)	A	Data(N)	A	P
---	-----	---	------------------	---	---------	---	-------	---------	---	---

Single Register Reading:

S	42H	A	Register Address	A	S	43H	A	Data	NA	P
---	-----	---	------------------	---	---	-----	---	------	----	---

Incremental Register Reading:

S	42H	A	Register Address	A	S	43H	A	Data(1)	A	Data(N)	NA	P
---	-----	---	------------------	---	---	-----	---	---------	---	-------	---------	----	---

Notes:

From master to slave

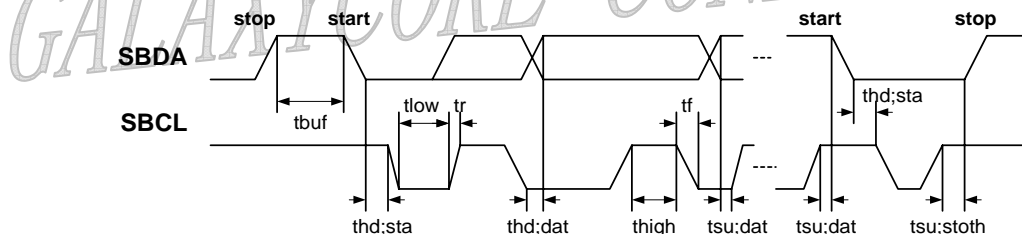

From slave to master

S: Start condition**P:** Stop condition**A:** Acknowledge bit**NA:** No acknowledge**Register Address:** Sensor register address**Data:** Sensor register value**3.2 Serial Bus Timing**

Parameter	Symbol	Min.	Max.	Unit
SBCL clock frequency	f _{scl}	0	400	KHz
Bus free time between a stop and a start	t _{buf}	1.2	*	μs
Hold time for a repeated start	t _{hd;sta}	1.0	*	μs
LOW period of SBCL	t _{low}	1.2	*	μs
HIGH period of SBCL	t _{high}	1.0	*	μs
Set-up time for a repeated start	t _{su;sta}	1.2	*	ns
Data hold time	t _{hd;dat}	1.3	*	ns
Data Set-up time	t _{su;dat}	250	*	ns
Rise time of SBCL, SBDA	t _r	*	250	ns
Fall time of SBCL, SBDA	t _f	*	300	ns
Set-up time for a stop	t _{su;sto}	1.2	*	μs
Capacitive load of bus line (SBCL, SBDA)	C _b	*	*	pf

4. Timing

Suppose Vsync is low active and Hsync is high active, and output format is YCbCr/RGB565, then the timing of vsync and hsync is bellowing:

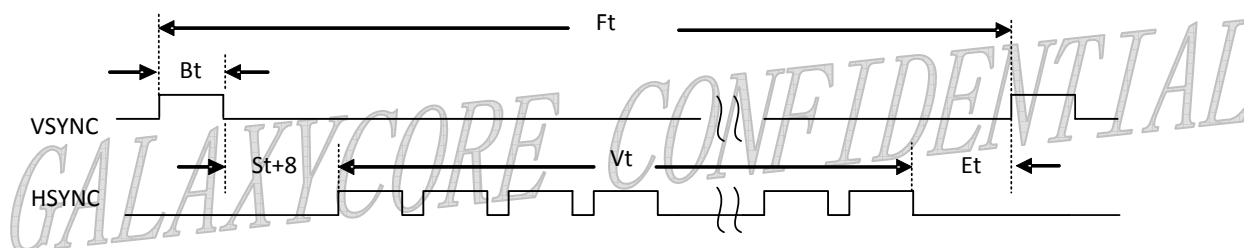

$$Ft = VB + Vt + 8 \quad (\text{unit is row_time})$$

$VB = Bt + St + Et$, Vblank/Dummy line, setting by register 0x0f[7:4] and 0x02.

Ft -> Frame time, one frame time

Bt -> Blank time, Vsync no active time.

St -> Start time, setting by register 0x0d.

Et -> End time, setting by register 0x0e.

Vt -> valid line time, VGA is 480, $Vt = \text{win_height} - 8$, win_height is setting by register 0x09 和 0x0a (488)。

When $\text{exp_time} \leq \text{win_height} + VB$, $Bt = VB - St - Et$. Frame rate is controlled by $\text{window_height} + VB$.

When $\text{exp_time} > \text{win_height} + VB$, $Bt = \text{exp_time} - \text{win_height} - St - Et$. Frame rate is controlled by exp_time.

The following is row_time calculate:

$$\text{row_time} = Hb + Sh_delay + \text{win_width} + 4.$$

Hb -> HBlank or dummy pixel, Setting by register 0x0f[3:0] and 0x01.

Sh_delay -> Setting by register 0x12.

win_width -> Setting by register 0x0b and 0x0c, $\text{win_width} = 6\text{final_output_width} + 8$. So for VGA, we should set win_width as 648.

5. DC Parameters

Symbol	Parameter	Min	Typ	Max	Unit
VDD28	Power supply	2.7	2.8	3.3	V
I _{DD}	Active(Operating) Current	--	25	--	mA
I _{DD5-PWDN}	Standby Current	--	10	--	uA
V _{IH}	Input voltage HIGH	0.7* VDD28			V
V _{IL}	Input voltage LOW			0.2* VDD28	V
V _{OH}	Output voltage HIGH	0.9* VDD28			V
V _{OL}	Output voltage LOW			0.1* VDD28	V
I _{OH}	Output current HIGH	8			mA

6. Register List

Analog & CISCTL

Address	Name	Width	Default Value	R/W	Description	
P0:0x00	Chip_ID	8	0x9b	RO	Chip version ID	
P0:0x01	Hb[8:0]	8	0x6a	RW	Horizontal blanking, unit pixel clock	
P0:0x02	Vb[8:0]	8	0x70	RW	Vertical blanking, if current exposure < (Vb + window Height) , frame rate will be determined by(Vb + window Height); otherwise frame rate will be determined by exposure time.	
P0:0x03	Exposure	high	4	0x0	RW	[7:4] NA [3:0] exposure[11:8], use line processing time as the unit.
P0:0x04	Exposure	low	8	0x96		Exposure[7:0], controlled by AEC if AEC is in function
P0:0x05	Rowstart	high	1	0x00	RW	Defines the starting row of the pixel array
P0:0x06		low	8	0x00		
P0:0x07	Column start	high	2	0x00	RW	Defines the starting column of the pixel array
P0:0x08		low	8	0x00		
P0:0x09	Window	high	1	0x1	RW	Defines image height, default 488
P0:0x0a	heigh	low	8	0xe8		
P0:0x0b	Window	high	2	0x2	RW	Defines image width default 648
P0:0x0c	width	low	8	0x88		
P0:0x0d	vs_st		8	0x02	RW	[7:0] number of Row time from frame start to first HSYNC valid
P0:0x0e	vs_et		8	0x04	RW	[7:0] number of Row time from last HSYNC

					valid to frame end Notice the relation with VB, VB > vs_st+vs_et
P0:0x0f	Vb[11:8] Hb[11:8]	4 4	0x00	RW	[7:4] Vb high 4 bits [3:0] Hb high 4 bits
P0:0x10	Rsh_width	8	0x22	RW	[7:4] restg_width, X2, [3:0] sh_width, X2,
P0:0x11	Tsp_width	8	0x0d	RW	[7:2] tx_width [1:0] space width x2
P0:0x12	Sh_delay	8	0x42	RW	Sample-hold delay time after row finish
P0:0x13	Row_tail_width	4	0x00	RW	[7:4] NA [3:0] Row_tail_width, generate more hsync for special application
P0:0x14	CISCTL_Mode1	8	0x00	RW	[7] hsync_always 1: hsync always on 0: hsync output at active output [6] NA [5:4] CFA sequence, determined once color filter is determined [3:2] NA [1] upside down [0] mirror
P0:0x15	CISCTL_mode2	8	0x0a	RW	[7:6] output_mode 0 0 VGA 0 1 even skip 1 0 CIF [5:4] reserved [3:2] reserved [1] new exposure mode [0] badframe_en, don't output bad frame
P0:0x16	CISCTL_mode3	8	0x05	RW	[7:5] NA [4] capture_ad_data_edge 1: use positive edge to sample data 0: use negative edge to sample data [3:0] Number of A/D pipe stages
P0:0x17	CISCTL_mode4	8	0x05	RW	[7:6] NA [5:3] reserved [2] black sun correction enable [1:0] black sun control registers
P0:0x18	NA			RW	NA
P0:0x19	NA			RW	NA
P0:0x1a	Analog mode 1	8	0x17	RW	[7] rsv1, reserved register #1

					<p>[6] rsv0, reserved register #0</p> <p>[5:4] coln_r</p> <p>2'b11 100u</p> <p>2'b10 80u</p> <p>2'b01 60u</p> <p>2'b00 40u</p> <p>[3:2] comv_r</p> <p>[1] clk_delay</p> <p>[0] apwd, 1 will power down all analog modules</p>
P0:0x1b	Analog mode 2	8	0x00	RW	<p>[7:2] reserved</p> <p>[1:0] reserved</p>
P0:0x1c	Hrst_rsg_v18 Da_rsg Txhigh_en Da18_r	1 3 1 2	0x41	RW	<p>[7] hrst enable, Pixel hard reset</p> <p>1: pixel hard reset enable</p> <p>0: normal pixel reset</p> <p>[6:4] da_rsg: row select gate low output voltage</p> <p>[3]TX_High enable</p> <p>[2] NA</p> <p>[1:0] da18_r, set internal D18 voltage</p> <p>2'b00 1.8V</p> <p>2'b01 1.88V</p> <p>2'b10 1.96V</p> <p>2'b11 2.04V</p>
P0:0x1d	Vref_v25	8	0xba	RW	<p>[7] vref_en, use internal reference voltage</p> <p>1: use internal Vref</p> <p>0: use external reference voltage supplied via the PAD</p> <p>[6:4] da_vref, set internal reference voltage</p> <p>3'b000 min</p> <p>3'b111 max</p> <p>[3] da25_en, use internal DA25</p> <p>1: use internal DA25</p> <p>0: use external DA25 supplied via the PAD</p> <p>[2] NA</p> <p>[1:0] da25_r, set internal DA25 voltage</p> <p>2'b00: 2.6V</p> <p>2'b01 2.5V</p> <p>2'b10 2.4V</p> <p>2'b11 2.3V</p>
P0:0x1e	ADC_R	8	0x11	RW	<p>[7] reserved</p> <p>[6:5] opa_r, ADC's operating current</p>

					[4:2] NA [1:0] sref
P0:0x1f	PAD_drv	8	0x15	RW	[7:6] NA [5:4] sync_drv 0 0: 4mA, 01: 8mA, 10: 12mA, 11: 16mA [3:2] data_drv 0 0: 4mA, 01: 6mA, 10: 10mA, 11: 12mA [1:0] pclk_drv 0 0: 2mA, 01: 4mA, 10: 8mA, 11: 10mA
P0:0xfe	Rest related	8		RW	[7] soft_reset [6:5] NA [4] CISCTL_restart_n, restart CISCTL, effective low [3:1] NA [0] page_select 1'b0 frequently used registers in REGF0 1'b1 registers in REGF1

ISP Related

Address	Name	Width	Default Value	R/W	Description
P0:0x20	Block_enable_1	8	0xff	RW	[7] BKS_en [6] gamma enable [5] CC enable [4] Edge enhancement enable [3] Interpolation enable [2] Noise removal enable [1] Defect removal enable [0] Lens-shading correction enable
P0:0x21	Block_enable_2	8	0xff	RW	[7] NA [6] blue_edge_en [5] skin correction enable [4] CbCr_HUE_en [3] Y_as_en [2] autogray_en [1] Y_gamma_en [0] HSP_en
P0:0x22	AAAA_enable	8	0x40	RW	[7] NA [6] auto_DNDD_en [5] auto_EE [4] auto_SA [3] NA [2] ABS enable [1] AWB enable [0] NA
P0:0x23	special_effect	8	0x00	RW	[7:3] NA [2] edge_map [1] CbCr fixed enable [0] Inverse color
P0:0x24	Output_format	8	0xa2	RW	[7] ISP high 8 or low 8 [6] output_delay_or_not [5] average chroma [4:0]output data mode 5'h00 Cb Y Cr Y 5'h01 Cr Y Cb Y 5'h02 Y Cb Y Cr 5'h03 Y Cr Y Cb 5'h06 RGB 565 5'h07 RGB x555

					<p>5'h08 RGB 555x 5'h09 RGB x444 5'h0a RGB 444x 5'h0b BGRG 5'h0c RGBG 5'h0d GBGR 5'h0e GRGB 5'h0f bypass 10bits 5'h11 only Y 5'h12 only Cb 5'h13 only Cr 5'h14 only R 5'h15 only G 5'h16 only B 5'h17 switch odd/even column /row to controls output bayer pattern</p> <p>P1:0x53[6:5]: 0 0 RGBG 0 1 RGGB 1 0 BGGR 1 1 GBRG</p> <p>5'h18 DNDD_out_mode, high 8 5'h19 LSC_out_mode, high 8</p>
P0:0x25	output_en	4	0x00	RW	[3]data_en, [2]pclk en [1]hsync_en, [0]vsync_en
P0:0x26	sync_mode	8	0x3f	RW	Synchronize signal output mode [7] data delay half [6] hsync delay half [5] allow pclk around hsync [4] allow pclk around vsync [3] opclk gated in HB 0: not gated 1: gated [2] opclk polarity 0: invert of isp_2pclk(isp_pclk) 1: same as isp_2pclk(isp_pclk) [1] hsync polarity 0: low valid 1: high valid [0] vsync polarity

					0: low valid 1: high valid
P0:0x27	NA				
P0:0x28	clk_div_mode	3	0x00	RW	[6:4] +1 represent the frequency division number [2:0] represent the high level in one pulse after frequency division Mclk by Div duty 0x11 2 1:1 0x21 3 1:2 0x22 3 2:1 0x31 4 1:3 0x32 4 2:2 0x33 4 3:1 ... 0x76 8 6:2 0x77 8 7:1
P0:0x29	bypass_mode	8	0x83	RW	[7]allow_hsync_in_row_tail [6]single_2_double_mode [5]first_second_switch [4]isp_bypass_no_gate_mode [3]is_8bit_bypass [2]is_10bit_bypass [1:0]bypass which 8bits from 11bit, in is_8bit_bypass mode 11: [10:3] 10: [9:2] 01: [8:1] 00: [7:0]
P0:0x2a	Clock_gating_en	8	0xff	RW	[7] ISP quiet mode [6:0] reserved
P0:0x2b	dither_mode	8	0x00	RW	[2]dither_en [1:0]dither to which stage
P0:0x2c	dither_bit	8	0x00	RW	Dither_bit
P0:0x2d	Debug_mode1	8	0x08	RW	[7:4] NA [3:2] pipe gate mode [1] AWB_gain_mode [0] more boundary mode
P0:0x2e	Debug_mode2	8	0x00	RW	[7:6] NA [5] reserved [4] NA [3] skin_map

					[2] NA [1] test image type1 [0] test image type2
P0:0x2f	Debug_mode3	8	0x01	RW	[7:1] NA [0] update_gain_mode
P0:0x46	Crop_win_mode Crop_win_y1 Crop_win_x1	8	0x0 0x0 0x0	RW	[7] crop window mode enable [6] NA [5:4] Crop win y0[9:8] [2:0] Crop win x0[10:8]
P0:0x47	Crop_win_y1	8	0x00	RW	Crop_win_y0[7:0]
P0:0x48	Crop_win_x1	8	0x00	RW	Crop_win_x0[7:0]
P0:0x49	Crop_win_height	1	0x01	RW	[7:1] NA [0] Crop_win_height[8]
P0:0x4a	Crop_win_height	8	0xe0	RW	Crop_win_height[7:0]
P0:0x4b	Crop_win_width	2	0x02	RW	[7:2] NA [1:0] Crop_win_width[9:8]
P0:0x4c	Crop_win_width	8	0x80	RW	Crop_win_width[7:0]

BLK

Address	Name	Width	Default Value	R/W	Description
P0:0x30	Blk_mode	8	0x24	RW	[7] dark current mode [6:4] BLK smooth speed [3:2] BLK Row select mode [1] dark current measure enable [0] offset enable
P0:0x31	Blk_limit_value	7	0x40	RW	[7] NA [6:0] Blk value limit
P0:0x32	Global_offset	7	0x01	RW	[7] NA [6:0] X2, global offset value
P0:0x33	Current_R_offset	6		RO	[7] NA [6:0] Current_R_offset
P0:0x34	Current_G_offset	6		RO	[7] NA [6:0] Current_G_offset
P0:0x35	Current_B_offset	6		RO	[7] NA [6:0] Current_B_offset
P0:0x36	Current_R_dark_current	6		RO	[7] NA [6:0] Current_R_dark_current
P0:0x37	Current_G_dark_current	7		RO	[7] NA [6:0] Current_G_dark_current
P0:0x38	Current_B_dark_current	8		RO	[7] NA

	current				[6:0] Current_B_dark_current
P0:0x39	Exp_rate_darkc	8	0x04	RW	Exp_rate_darkc
P0:0x3a	offset_submode, offset_ratio	2 6	0x00 0x20	RW	[7:6] offset sub mode [5:0] offset ratio, 1.5 bits
P0:0x3b	darkc_submode, dark_current_ratio	2 6	0x00 0x10	RW	[7:6] dark current sub mode [5:0] dark current ratio, 1.5 bits
P0:0x3c	Manual_G1_offset	6	0x02	RW	S5
P0:0x3d	Manual_R1_offset	6	0x3e	RW	S5
P0:0x3e	Manual_B2_offset	6	0x3f	RW	S5
P0:0x3f	Manual_G2_offset	6	0x03	RW	S5

PREGAIN

Address	Name	Width	Default Value	R/W	Description
P0:0x50	Global_gain	6	0x12	RW	[7:6] NA [5:0] global_gain, 2.4bits, 0x10 is 1.0x
P0:0x51	Auto_pregain	8	0x40	RO	Controlled by AEC , can be manually controlled when disable AEC
P0:0x52	Auto_postgain	8	0x40	RO	Controlled by AEC , can be manually controlled when disable AEC
P0:0x53	Channel_gain_G1	8	0x80	RW	1.7 bits, G1 channel pre gain
P0:0x54	Channel_gain_R	8	0x80	RW	1.7 bits, R channel pre gain
P0:0x55	Channel_gain_B	8	0x80	RW	1.7 bits, B channel pre gain
P0:0x56	Channel_gain_G2	8	0x80	RW	1.7 bits, G2 channel pre gain
P0:0x57	R_ratio	8	0x80	RW	1.7 bits, R_ratio
P0:0x58	G_ratio	8	0x80	RW	1.7 bits, G_ratio
P0:0x59	B_ratio	8	0x80	RW	1.7 bits, B_ratio
P0:0x5a	AWB_R_gain	8	0x50	RW	2.6 bits, red channel gain from AWB
P0:0x5b	AWB_G_gain	8	0x40	RW	2.6 bits, green channel gain from AWB
P0:0x5c	AWB_B_gain	8	0x48	RW	2.6 bits, blue channel gain from AWB
P0:0x5d	Lsc_decrease_level1	6	0x12	RW	[7:6] NA [5:0] 4.2bits, Lsc_decrease_level1_gain
P0:0x5e	Lsc_decrease_level2	6	0x1a	RW	[7:6] NA [5:0] 4.2bits, Lsc_decrease_level2_gain

P0:0x5f	Lsc_decrease_level3	6	0x24	RW	[7:6] NA [5:0] 4.2bits, Lsc_decrease_level3_gain
---------	---------------------	---	------	----	---

LSC

Address	Name	Width	Default Value	R/W	Description
P0:0x8b	LSC red b2	8	0x40	RW	Square coefficient for R,G,B channel
P0:0x8c	LSC green b2	8	0x40	RW	
P0:0x8d	LSC blue b2	8	0x40	RW	
P0:0x8e	LSC red b4	8	0x30	RW	Quadra coefficient for R,G,B channel
P0:0x8f	LSC green b4	8	0x30	RW	
P0:0x90	LSC blue b4	8	0x30	RW	
P0:0x91	Signed b4 LSC row center	1 7	0x60	RW	[7] controls the sign of quadric coefficient, default 0 [6:0] row center for LSC correction X4
P0:0x92	LSC column center	8	0x80	RW	Column center for LSC correction X4

ASDE (auto saturation de-noise and edge enhancement)

Address	Name	Width	Default Value	R/W	Description
P0:0x69	ASDE gain high threshold	8	0x20	RW	Gain high threshold, 4.4bits,
P0:0x6a	ASDE_DN_c_slope ASDE_gain_mode	4 4	0x0a 0x0f	RW	[7:4] de noise center slope, float 1.3 [3] select current post gain, [2] selects current pre gain [1] select global gain [0] NA
P0:0x6b	ASDE_DN_b_slope ASDE_DN_n_slope	4 4	0x0a 0x0a	RW	[7:4] ASDE_DN_b_slope [3:0] ASDE_DN_n_slope
P0:0x6c	ASDE_DD_bright_th_start ASDE_DD_brighth_th_slope	4 4	0x05 0x0f	RW	[7:4] ASDE_DD_bright_th_start [3:0] ASDE_DD_brighth_th_slope
P0:0x6d	ASDE_DD_limit_start ASDE_DD_limit_slope	4 4	0x08 0x0f	RW	[7:4] ASDE_DD_limit_start [3:0] ASDE_DD_limit_slope
P0:0x6e	ASDE_auto_EE1_effect_start	4	0x05	RW	[7:4] ASDE_auto_EE1_effect_start [3:0] ASDE_auto_EE1_effect_slope

	ASDE_auto_EE1_effect_slope	4	0x08		
P0:0x6f	ASDE_auto_EE2_effect_start	4	0x04	RW	[7:4] ASDE_auto_EE2_effect_start, [3:0] ASDE_auto_EE2_effect_slope,
	ASDE_auto_EE2_effect_slope	4	0x08		
P0:0x70	ASDE_auto_saturation_dec_slope	8	0x10	RW	ASDE_auto_saturation_dec_slope
P0:0x71	ASDE_auto_saturation_low_limit	4	0x03	RW	[7:4] ASDE_auto_saturation_low_limit, [3:0] ASDE_sub_saturation_slope
	ASDE_sub_saturation_slope	4	0x01		

DNDD

Address	Name	Width	Default Value	R/W	Description
P0:0x60	DN_mode_en	8	0x07	RW	[7:5] NA [4] zero_weight_mode [3] share mode [2] c_weight_adap_mode [1] dn_lsc_mode [0] dn_b_mode
P0:0x61	DN_mode_ratio		0x22	RW	[7:6] NA [5:4] C_weight_adaptive_ratio [3:2] dn_lsc_ratio [1:0] dn_b_mode_ratio
P0:0x62	DN_bilat_b_base	6	0xc	RW	Fixed bilateral b value
P0:0x63	DN_b_incr	5	0x0	RW	[7:5] NA [4:0] increase de-noise at low luminance condition, controlled by ASDE module
P0:0x64	DN_bilat_n_base	4	0x00	RW	[7:4] Base noise level of each frame
	DN_C_weight	4	0x05		[3:0] base center pixel weight
P0:0x65	DN_n_incr	4	0x08	RW	[7:4] DN_n_incr
	DN_C_coeff	4	0x08		[3:0] DN_C_coeff controlled by ASDE module or user
P0:0x66	DD_dark_bright_TH	4	0xe	RW	[7:4] dark threshold [3:0] bright threshold controlled by ASDE or user, should be set >=2
P0:0x67	DD_flat_TH	8	0x86	RW	Threshold to define a flat

P0:0x68	DD_limit	4	0x08	RW	[7:4] DD_limit, threshold of a defect pixel
	DD_ratio	4	0x02		[3:2] NA [1:0] DD_ratio, controls the difference between bright and dark pixel

INTPEE (Interpolation and Edge Enhancement)

Address	Name	Width	Default Value	R/W	Description
P0:0x72	EEINTP mode 1	8	0xec	RW	[7] edge add mode1 [6] new edge mode (HP3 mode) [5] edge2 mode [4] HP mode [3] LP interpolation enable [2] LP edge enable [1:0] LP edge mode
P0:0x73	EEINTP mode 2	8	0x80	RW	[7] edge_add_mode2 [6]NA [5] direction mode [4] fixed direction threshold [3:0] reserved
P0:0x74	Direction TH1	6	0x05	RW	Lower Criteria for direction detection
P0:0x75	Direction TH2	6	0x3f	RW	Upper Criteria for direction detection
P0:0x76	Diff_HV_TI_TH	4	0x05	RW	[7:4] Diff_HV_TI_TH
	Direction diff TH	4	0x00		[3:0] Direction diff TH
P0:0x77	Edge1 effect	4	0x08	RW	[7:4] edge effect1
	Edge2 effect	4	0x04		[3:0] edge effect 2 Controlled by user or ASDE
P0:0x78	Edge_pos_ratio	4	0x08	RW	[7:4] pos edge ratio , 1.3Bits
	Edge_neg_ratio	4	0x08		[3:0] neg edge ratio , 1.3Bits
P0:0x79	Edge1_max	4	0x6	RW	[7:4] edge1 max
	Edge1_min	4	0x1		[3:0] edge1 min
P0:0x7a	Edge2_max	4	0x6	RW	[7:4] edge2 max
	Edge2_min	4	0x1		[3:0] edge2 min
P0:0x7b	Edge1_th	4	0x2	RW	[7:4] edge1 threshold
	Edge2_th	4	0x2		[3:0] edge2 threshold
P0:0x7c	Edge_pos_max	4	0x0f	RW	[7:4] Pos_edge_max
	Edge_neg_max	4	0x08		[3:0] Neg_edge_max

ABB

Address	Name	Width	Default Value	R/W	Description
---------	------	-------	---------------	-----	-------------

P0:0x80	ABB mode	3	0x03	RW	[7:3] NA [2:1] ABB row select mode [0] ABB enable
P0:0x81	ABB target average	8	0x05	RW	S7, black stretch target average, allow negative target value.
P0:0x82	ABB target average	8	0x33	RW	S7, black stretch target average, allow negative target value
P0:0x83	ABB limit value	7	0x20	RW	[7] NA [6:0] black point criteria
P0:0x84	ABB speed	8	0x22	RW	[7] NA [6:4] fast speed [3] NA [2:0] IIR smooth speed
P0:0x85	Current R black level	7	0x08	RW	[7] NA [6:0] channel R black level aligns to lower 7 bit of 10 bit input data, controlled by ABB or user
P0:0x86	Current G black level	7	0x09	RW	[7] NA [6:0] channel G black level aligns to lower 7 bit of 10 bit input data, controlled by ABB or user
P0:0x87	Current B black level	7	0x0a	RW	[7] NA [6:0] channel B black level aligns to lower 7 bit of 10 bit input data, controlled by ABB or user
P0:0x88	Current R black factor	8	0x09	RW	Used to fine tune R black value, Lower 8 of 10, controlled by ABB or user
P0:0x89	Current G black factor	8	0x0b	RW	Used to fine tune G black value, Lower 8 of 10, controlled by ABB or user
P0:0x8a	Current B black factor	8	0x0d	RW	Used to fine tune B black value, Lower 8 of 10, controlled by ABB or user

CC

Address	Name	Width	Default Value	R/W	Description
P0:0x93	CC Matrix C11	8	0x44	RW	R channel coefficient 1, S1.6
P0:0x94	CC Matrix C12	8	0xfe	RW	R channel coefficient 2, S1.6
P0:0x95	CC Matrix C13	8	0xfe	RW	R channel coefficient 3, S1.6
P0:0x96	CC Matrix C21	8	0xfe	RW	G channel coefficient 1, S1.6
P0:0x97	CC Matrix C22	8	0x44	RW	G channel coefficient 2, S1.6

P0:0x98	CC Matrix C23	8	0xfe	RW	G channel coefficient 3, S1.6
P0:0x9c	CC Matrix C41	5	0x00	RW	R channel offset coefficient, S4
P0:0x9d	CC Matrix C42	5	0x00	RW	G channel offset coefficient, S4
P0:0x9e	CC Matrix C43	5	0x00	RW	B channel offset coefficient, S4

GAMMA

Address	Name	Width	Default Value	R/W	Description
P0:0x9f	Gamma_out0	8	0x10	RO	Each out value of knee_i. Knee0=0
P0:0xa0	Gamma_out1	8	0x20	RO	Knee1=8
P0:0xa1	Gamma_out2	8	0x38	RO	Knee2=16
P0:0xa2	Gamma_out3	8	0x4E	RO	Knee3=24
P0:0xa3	Gamma_out4	8	0x63	RO	Knee4=32
P0:0xa4	Gamma_out5	8	0x76	RO	Knee5=40
P0:0xa5	Gamma_out6	8	0x87	RO	Knee6=48
P0:0xa6	Gamma_out7	8	0xa2	RO	Knee7=64
P0:0xa7	Gamma_out8	8	0xb8	RO	Knee8=80
P0:0xa8	Gamma_out9	8	0xca	RO	Knee9=96
P0:0xa9	Gamma_out10	8	0xd8	RO	Knee10=112
P0:0xaa	Gamma_out11	8	0xe3	RO	Knee11=128
P0:0xab	Gamma_out12	8	0xe9b	RO	Knee12=144
P0:0xac	Gamma_out13	8	0xf0	RO	Knee13 =160
P0:0xad	Gamma_out14	8	0xf8	RO	Knee14 = 192
P0:0xae	Gamma_out15	8	0xfd	RO	Knee15 = 224
P0:0xaf	Gamma_out16	8	0xff	RO	Knee16 = 256

YCP

Address	Name	Width	Default Value	R/W	Description
P0:0xb0	Global saturation	8	0x40	RW	Global saturation, controlled by auto_saturation
P0:0xb1	saturation_Cb	8	0x30	RW	Cb saturation 3.5bits, 0x20=1.0
P0:0xb2	saturation_Cr	8	0x30	RW	Cr saturation 3.5bits, 0x20=1.0
P0:0xb3	luma_contrast	8	0x40	RW	Luma_contrast, can be adjusted via contrast center 2.6bits, 0x40=1.0
P0:0xb4	Contrast center	8	0x80	RW	Contrast center value
P0:0xb5	Luma_offset	8	0x00	RW	Add offset on luma value. S7.

P0:0xb6	skin_Cb_center	8	0xe8	RW	Cb criteria for skin detection.
P0:0xb7	skin_Cr_center	4	0x18	RW	Cr criteria for skin detection.
P0:0xb8	Skin radius square	8	0x28	RW	Defines skin range
P0:0xb9	Skin brightness high	4	0xe	RW	[7:4] skin brightness high threshold
	Skin brightness low	4	0x3		[3:0] skin brightness low threshold
P0:0xba	Fixed_Cb	8	0x00	RW	S7, if fixed CbCr function is enabled, current image Cb value will be replace by this value to achieve special effect
P0:0xbb	Fixed_Cr	8	0x00	RW	S7, if fixed CbCr function is enabled, current image Cr value will be replace by this value to achieve special effect
P0:0xbc	NA				
P0:0xbd	Edge_dec_sa_en	3		RW	[7] NA
	Edge_dec_sa_slope	4			[6:4] edge_dec_sa_en [3:0] edge_dec_sa_slope
P0:0xbe	auto-gray mode	2	0x12		[7:6] NA
	Sa_autogray	4			[5:4] auto gray mode [3:0] sa_autogray point
P0:0xbf	Saturation_sub_strength	8	0x00	RO	Chroma offset in low light
P0:0xc0	Y_Gamma_out0	8		RW	Knee0=0
P0:0xc1	Y_Gamma_out1	8		RW	Knee1=8
P0:0xc2	Y_Gamma_out2	8		RW	Knee2=16
P0:0xc3	Y_Gamma_out3	8		RW	Knee3=32
P0:0xc4	Y_Gamma_out4	8		RW	Knee4=48
P0:0xc5	Y_Gamma_out5	8		RW	Knee5=64
P0:0xc6	Y_Gamma_out6	8		RW	Knee6=80
P0:0xc7	Y_Gamma_out7	8		RW	Knee7=96
P0:0xc8	Y_Gamma_out8	8		RW	Knee8=128
P0:0xc9	Y_Gamma_out9	8		RW	Knee9=160
P0:0xca	Y_Gamma_out10	8			Knee10=192
P0:0xcb	Y_Gamma_out11	8			Knee11=224
P0:0xcc	Y_Gamma_out12	8			Knee12=255

AEC

Address	Name	Width	Default Value	R/W	Description
P0:0xd0	AEC_mode1	8	0xca	RW	[7] reserved [6] NA [5] exposure mode 1: level exp 0: N step mode [4] NA [3: 2] gain mode [1] measure point [0] skip mode in luminance detection
P0:0xd1	AEC_mode2	8	0x21	RW	[7] fix target [6:4] AEC take action every N frame [3:2] close frame number to eliminate bad frame [1] change exp_gain_mode [0] dead_zone_mode
P0:0xd2	AEC_mode3	8	0x00	RW	[7] AEC_en [6] map measure point [5] color Y mode [4] skin weight mode [3] NA [2] color select [1:0] NA
P0:0xd3	AEC_target_Y	8	0x48	RW	expected luminance value
P0:0xd4	Y_average	8	0x00	RO	Current frame luma average
P0:0xd5	AEC_high_low_range	8	0xf2	RW	[7:4] x16, count limit for high luminance pixels [3:0] x4, count limit for low luminance pixels
P0:0xd6	AEC_ignore	5	0x18	RW	[4] aec_ignore_enable [3:0] aec ignore number
P0:0xd7	AEC_number_limit_high_range	8	0x35		AEC_number_limit_high_range
P0:0xd8	NA				
P0:0xd9	AEC_skin_offset	4	0x88	RW	[7:4] AEC_skin_offset
	AEC_R_offset	4			[3:0] AEC_R_offset
P0:0xda	AEC_G_offset	4	0x88	RW	[7:4] AEC_G_offset
	AEC_B_offset	4			[3:0] AEC_B_offset
P0:0xdb	AEC_slow_margi	4	0x9	RW	[7:4] AEC slow margin, X4

	n AEC_slow_speed	3	0x6		[3] NA [2:0] AEC slow speed
P0:0xdc	AEC_fast_margin AEC_fast_speed	4 3	0x9 0x6	RW	[7:4] AEC fast margin, X4 [3] NA [2:0] AEC fast speed
P0:0xdd	AEC_exp_change gain_ratio	8	0x96	RW	Gain change criteria, float 1.7, default use 1.2x
P0:0xde	AEC_step2_sunlight	8	0x02	RW	AEC_step2_sunlight
P0:0xdf	AEC_I_frames AEC_D_ratio	2 4	0x33	RW	[7:6] NA [5:4] integration period [3:0] differential coefficient
P0:0xe0	AEC_I_stop_L _margin	7	0x7	RW	[7] NA [6:0] x2, AEC_I_stop_L _margin
P0:0xe1	AEC_I_stop_mar gin AEC_I_ratio	4 4	0x61	RW	[7:4] AEC adjust stop margin [3:0] integration coefficient
P0:0xe2	Anti_flicker_step [11:8]	4	0x0	RW	[7:4] NA [3:0] flicker step [11:8]
P0:0xe3	Anti_flicker_step [7:0]	8	0x96	RW	[7:0] flicker step [7:0]
P0:0xe4	exp_level_1 high	4	0x02	RW	Exposure level 1
P0:0xe5	exp_level_1 low	8	0x58	RW	
P0:0xe6	exp_level_2 high	4	0x03	RW	Exposure level 2
P0:0xe7	exp_level_2 low	8	0x84	RW	
P0:0xe8	exp_level_3 high	4	0x07	RW	Exposure level 3
P0:0xe9	exp_level_3 low	8	0x08	RW	
P0:0xea	exp_level_4 high	4	0x0d	RW	Exposure level 4
P0:0xeb	exp_level_4 low	8	0x7a	RW	
P0:0xec	Max_exp_level Exp_min_l[11:8]	2 4	0x20	RW	[7:6] NA [5:4] max exposure levels can be applied by AEC [3:0] minimum exposure level high 4 bits
P0:0xed	Exp_min_l[7:0]	8	0x4	RW	minimum exposure level lower 8 bits
P0:0xee	Max_post_dg_ga in	8	0xc0	RW	Digital post gain limit, float 2.6 ,X3
P0:0xef	Max_pre_dg_gai n	8	0x60	RW	Digital pre gain limit, float 2.6, X1.5

ABS

Address	Name	Width	Default Value	R/W	Description
P0:0xf0	ABS_range_com pesate ABS_skip_frame	4 3	0x3	RW	[7:4] X4+3, add "more range" to enlarge more stretch [3] NA [2:0] Set number of frames to be skipped in ABS adjustment
P0:0xf1	ABS_stop_margi n	4	0x2	RW	[7:4] NA [3:0] margin for ABS to stop adjustment
P0:0xf2	Y_S_compesate ABS_manual_K	4 4	0x00	RW	[7:4] Y_S_compesate [3:0] manual ABS slope adjustment, default 0
P0:0xf3	Y_stretch_limit	7	0x30	RW	[7] NA [6:0] Y_stretch limit
P0:0xf4	Y_tilt	8		RO	[7:0] the corner point, stretch Y if less than it
P0:0xf5	Y_stretch_K	8		RO	[7:0] the slope ABS calculated for Y less than Y_tilt, 2.6bits

Measure Window

Address	Name	Width	Default Value	R/W	Description
P0:0xf7	Big_win_x0	6	0x04	RW	Measure big window left column number, X4
P0:0xf8	Big_win_y0	6	0x02	RW	Measure big window left row number, X4
P0:0xf9	Big_win_x1	8	0x98	RW	Measure big window right column number, X4
P0:0xfa	Big_win_y1	8	0x70	RW	Measure big window right row number, X4
P0:0xfb	Diff_Y_big_thd		0x20	RW	Light change threshold

OUT Module

Address	Name	Width	Default Value	R/W	Description
P1:0x50	Close_frame_en Close_frame_nu m	1 4	0x00	RW	[7:5] NA [4] close frame function enable, close output Vsync to control frame rate [3:0] frames to be closed should be selected from this pool
P1:0x51	Close_frame_nu	8	0x00	RW	These two registers is a combi of four 4bit

	m1				registers, they defines up to any 4 frames
P1:0x52	Close_frame_num2	8	0x00	RW	to be closed
P1:0x53	Bayer_mode	8	0x82	RW	[7] opclk gated enable in subsample [6] odd even row switch [5] odd even column switch [4:0] pixel count limit to extend row in tail, do NOT less than 2
P1:0x54	subsample	8	0x03	RW	[7] use_or_cut_row [6:4]subsample row ratio [3] use_or_cut_col [2:0]subsample col ratio
P1:0x55	sub_mode	2	0x03	RW	[1] neighbor vag mode [0] subsample_extend_opclk
P1:0x56	sub_row_N1	6	0x00	RW	[5:3]sub_row_num1 [2:0] sub_row_num2
P1:0x57	sub_row_N2	6	0x00	RW	[5:3]sub_row_num3 [2:0] sub_row_num4
P1:0x58	sub_col_N1	6	0x00	RW	[5:3]sub_col_num1 [2:0] sub_col_num2
P1:0x59	sub_col_N2	6	0x00	RW	[5:3]sub_col_num3 [2:0] sub_col_num4

AWB

Address	Name	Width	Default Value	R/W	Description
P1:0x00	AWB_RGB_high_low	8	0xf5	RW	Defines the RGB range of gray pixel to be selected
P1:0x02	AWB_Y_to_C_diff2	8	0x18	RW	Gray pixel criteria
P1:0x04	AWB_C_max	8	0x02	RW	Chroma limit
P1:0x05	AWB_C_inter	8	0x22	RW	Slope of interested zone upper bond
P1:0x06	AWB_C_inter2	8	0x40	RW	Slope of interested zone lower bond
P1:0x08	AWB_C_max_big	8	0x50	RW	Chroma limit when big_c mode enable
P1:0x09	AWB_Y_high	8	0x40	RW	Give high luminance point more weight
P1:0x0a	AWB_number_limit	8	0x90	RW	Number limit

P1:0x0b	Kwin_ratio Sel_point Skip_mode	3 1 2	0x6 0 0	RW	[7] NA [6] block threshold selection 1: use maximum threshold 0: use threshold defined by [5:4], default [5:4] small blocks validation criteria [3] NA [2] AWB sample location [1:0]AWB skip mode
P1:0x0c	Kwin_thd	3	0x6	RW	[7:5] NA [4:0] block min range limit
P1:0x0d	Light_gain_range	8	0x30	RW	Defines gain_range in R/B_gain domain.
P1:0x0e	Small_win _width_step	8	0x49	RW	Small_win _width_step
P1:0x0f	Small_win _height_step	8	0x36	RW	Small_win _height_step
P1:0x10	AWB_yellow_TH AWB_big_c_limit	4 4	0x42	RW	[7:4] AWB yellow block threshold [3:0] AWB_big_c_block_limit
P1:0x11	AWB_mode	8	0xf	RW	reserved
P1:0x12	AWB_adjust_spe ed AWB_adjust_ma rgin	3 4	0x42	RW	[7] NA [6:4] AWB gain adjust speed, the bigger the quicker. [3:0] AWB_adjust_margin
P1:0x13	AWB_every_N AWB_light ct_mode	2 4	0x21	RW	[7:6] NA [5:4] AWB every N [3] No FIR [2] FIR smooth mode [1] NA [0] use ct mode
P1:0x14~ 0x1e	AWB_set1	8	--	RW	reserved
P1:0x70~ 0x79	AWB_set2	8	--	RW	reserved
P1:0xd0	R_avg_use	8		RO	R_avg_use
P1:0xd1	G_avg_use	8		RO	G_avg_use
P1:0xd2	B_avg_use	8		RO	B_avg_use

7. Pin Description

7.1 GC0308 CSP package Top view (unit:um)

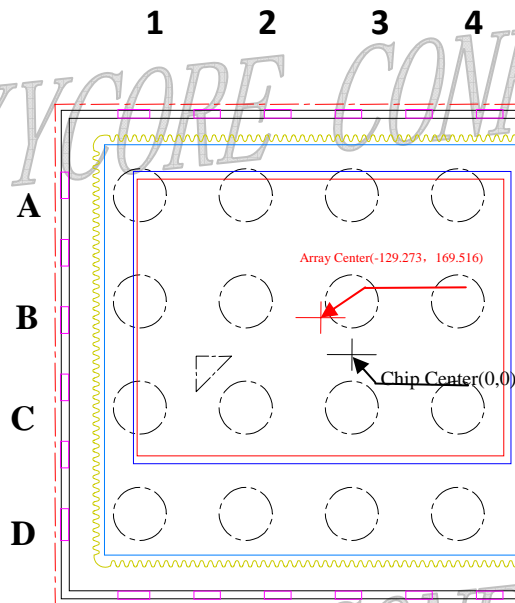

7.2 CSP ball description

	1	2	3	4	5
A	AVDD25	VREF	SBDA	SBCL	D<7>
B	GND	PWDN	HSYNC	D<6>	D<5>
C	VSYNC	D<0>	D<3>	D<4>	PCLK
D	DVDD28	D<1>	D<2>	RESETB	INCLK

7.3 GC0308 chip pin description

Pin	Name	Pin Type	Function
A1	AVDD25	Power	Internal analog voltage. Please connect 0.1uF or 0.47uF capacity to ground.
A2	VREF	Power	Internal reference voltage. Please connect 0.1uF or 0.47uF capacity to ground.
A3	SBDA	I/O	Two-wire serial bus, data
A4	SBCL	Input	Two-wire serial bus, clock

A5	D<7>	Output	YUV/RGB data output bit[7]
B1	GND	Ground	Chip ground
B2	PWDN	Input	Sensor power down control: 0: normal work 1: standby
B3	HSYNC	Output	HSYNC output
B4	D<6>	Output	YUV/RGB data output bit[6]
B5	D<5>	Output	YUV/RGB data output bit[5]
C1	VSYNC	Output	VSYNC output
C2	D<0>	Output	YUV/RGB data output bit[0]
C3	D<3>	Output	YUV/RGB data output bit[3]
C4	D<4>	Output	YUV/RGB data output bit[4]
C5	PCLK	Output	Pixel clock output
D1	DVDD28	Power	Main power supply pin, typical 2.8V, Please connect 0.1uF or 0.47uF capacity to ground.
D2	D<1>	Output	YUV/RGB data output bit[1]
D3	D<2>	Output	YUV/RGB data output bit[2]
D4	RESETB	Input	Chip reset control: 0: chip reset 1: normal work
D5	INCLK	Input	Main clock

7.4 CSP package mechanical drawing (unit:um)

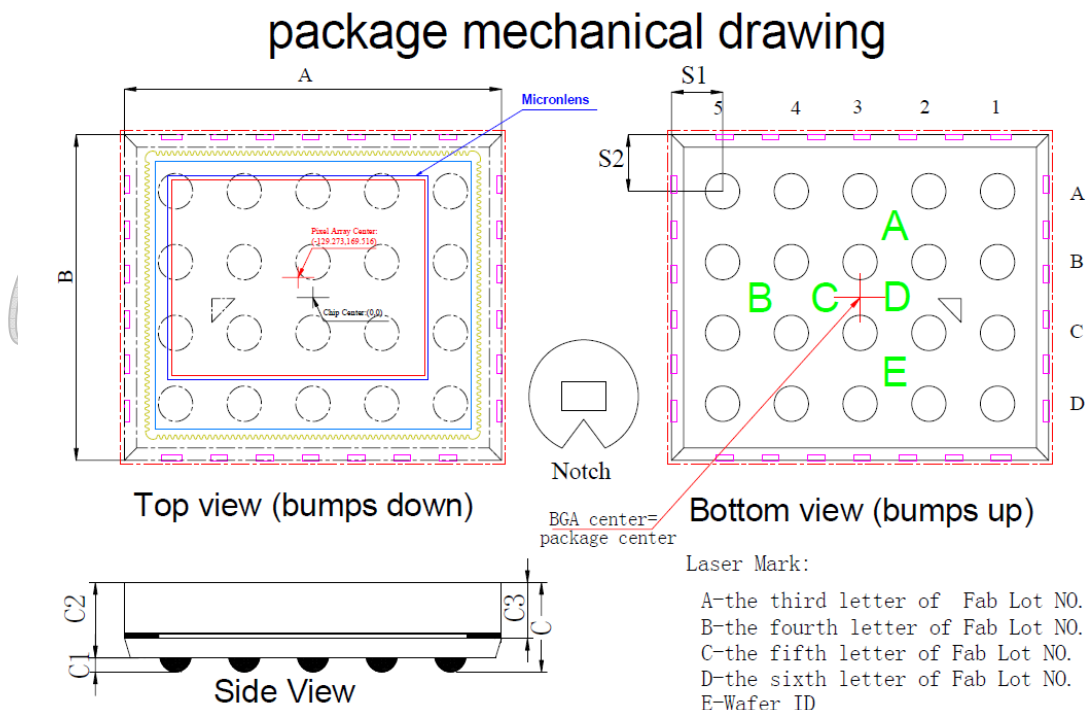

Description	Symbol	Nominal	Min.	Max.
		Millimeters		
Package Body Dimension X	A	3.290	3.265	3.315
Package Body Dimension Y	B	2.758	2.733	2.783
Package Height	C	0.775	0.715	0.835
Ball Height	C1	0.160	0.130	0.190
Package Body Thickness	C2	0.615	0.580	0.650
Thickness from top glass surface to wafer	C3	0.435	0.415	0.455
Ball Diameter	D	0.300	0.270	0.330
Total Ball Count	N	20		
Ball Count X axis	N1	5		
Ball Count Y axis	N2	4		
Pins Pitch X axis	J1	0.600		
Pins Pitch Y axis	J2	0.600		
Edge to Pin Center Distance along X	S1	0.445	0.415	0.475
Edge to Pin Center Distance along Y	S2	0.479	0.449	0.509